

Fremont County, Iowa
Horizontal Datum: **NAD 83(2011)** - Vertical Datum: **NAVD 1988**
Iowa State Plane South Zone (1402)
Iowa Regional Coordinate System Zone 6 Council Bluffs
US Survey Feet
2015

Point Name: **35**

Designation: 2010-035 Fremont Co GPS Control Pt (Set by DCI in 2010)

NAD 83(NA2011) Latitude: **N40°40'26.17487"** Longitude: **W95°43'25.03108"**
NAVD 88 Ortho Height: **918.457sft** Ellip. Ht: **820.967sft** **Geoid12A**

Iowa South Zone (1402) Northing: **253420.295sft** Easting: **1023681.373sft**
Mapping Angle: **-1°27'53"** Combination Scale Factor: **0.999951211**

IaRCS Zone 6 Northing: **6754453.075sft** Easting: **16502694.551sft**
Mapping Angle: **0°00'23"** Combination Scale Factor: **0.999999832**

Monument Type: Berntsen 3/4" Top Security Rod Monument with a 2-1/2" dia. domed survey cap and permanent magnet encased in a white PVC pipe with a NGS style alum. access cover.

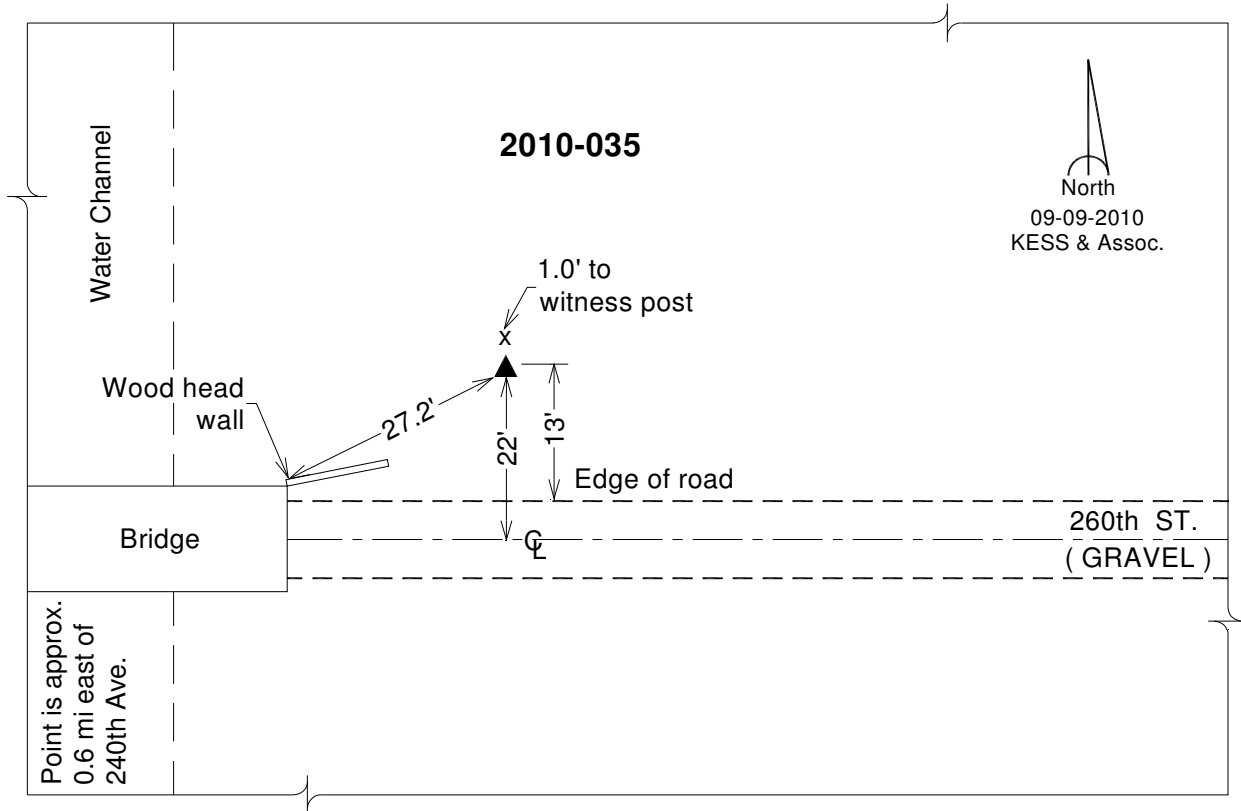

This document was prepared by DCI on January 9, 2015 for use by Fremont County, Iowa