

Page County, Iowa
Iowa South Zone (1402)
Horiz. Datum: **NAD83(NA2011)**
Vert. Datum: NAVD 1988
US Survey Feet
2013

Point Name: **27**

Designation: 2008-027 Page Co GPS Control Pt (Set by DCI in 2008)

Northing: **285689.00**sft Easting: **1244987.52**sft

Orthometric Height: **1090.41**sft Ellipsoid Height: **988.73**sft **Geoid12A**

Latitude: **N40°46'30.85992"** Longitude: **W94°55'40.08042"**

Mapping Angle: **-0°56'26"** Combination Scale Factor: **0.999928619**

Monument Type: Berntsen 3/4" Top Security Rod Monument with a 2-1/2" dia. domed survey cap and permanent magnet encased in a white PVC pipe with a NGS style alum. access cover.

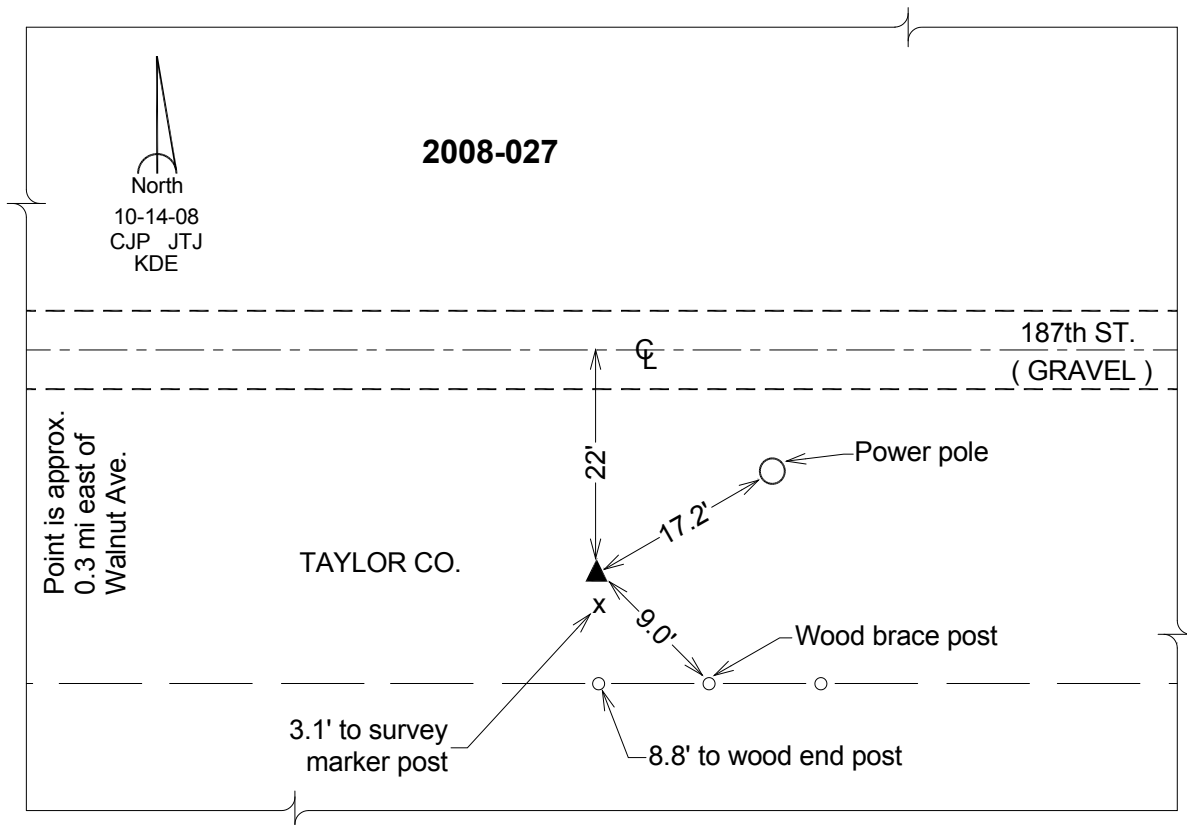

This document was prepared by DCI on 04-16-2013 for use by Page County, Iowa.